

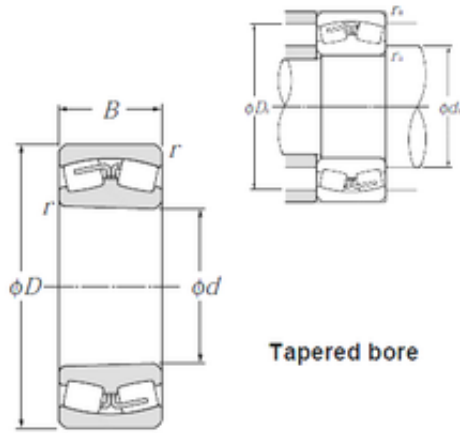

239/1180K NTN Spherical Roller Bearings



Bearing No. 239/1180K

239/1180K Bearing 2D drawings and 3D CAD models

Size	1180x1540x272 mm
Bore Diameter	1180 mm
Outer Diameter	1540 mm
Width	272 mm
d	1180 mm
D	1 540 mm
B	272 mm
C	272 mm
r min.	7,5 mm
da min.	1 216 mm
Da max.	1 504 mm
ra max.	6 mm
Weight	1 340 Kg
Basic dynamic load rating (C)	11 000 kN
Basic static load rating (C0)	29 800 kN
(Grease) Lubrication Speed	140 r/min
(Oil) Lubrication Speed	180 r/min
Calculation factor (e)	0,15
Calculation factor (Y0)	4,3
Calculation factor (Y1)	4,4