

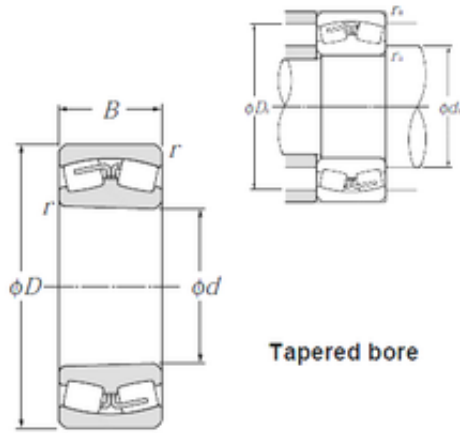

239/1060K NTN Spherical Roller Bearings



Bearing No. 239/1060K

239/1060K Bearing 2D drawings and 3D CAD models

Size	1060x1400x250 mm
Bore Diameter	1060 mm
Outer Diameter	1400 mm
Width	250 mm
d	1060 mm
D	1 400 mm
B	250 mm
C	250 mm
r min.	7,5 mm
da min.	1 096 mm
Da max.	1 364 mm
ra max.	6 mm
Weight	1 060 Kg
Basic dynamic load rating (C)	9 300 kN
Basic static load rating (C0)	24 700 kN
(Grease) Lubrication Speed	160 r/min
(Oil) Lubrication Speed	210 r/min
Calculation factor (e)	0,16
Calculation factor (Y0)	4,19
Calculation factor (Y1)	4,28